



Centium T5HO

CENTIUM ELE BALLAST (2) F54T5/HO 120-277V

No matter what the conditions require, operating at a variety of line voltages between 120V to 480V, whether located in high ambient temperature environments (requiring a 90° C rating) or not, our family of Philips Advance Centium ballasts are ideal for a wide variety of applications.

Product data

General Information	
Lamp Type	F54T5/HO
Number of Lamps	1/2 piece/unit
Ballast Type	Electronic Fluorescent
Base Model	ICN2S54N
Suitable For Outdoor Use	Yes
Automatic Restart	Yes
Operating and Electrical	
Input Voltage	120 to 277 V
Input Frequency	50 to 60 Hz
Total Harmonic Distortion USA	10 %
Ignition Method	Programmed Start
Crestfactor (Nom)	1.7
Ignition Time (Nom)	1.5 s
Ballast Factor (Nom)	1
Power Factor (Nom)	0.98
Input Current (Max)	1.00 A
Input Current (Min)	0.43 A
Input Power (Nom)	120-116 W
Rated Lamp Power	54 W

Wiring	
Color Input Terminals	No terminals
Color Output Terminals	No terminals
Wire Striplength	0.50/0.375 mm
Lamp Connection	Series
Wire Length by Color	See data sheet
Wire Gauge (Nom)	18AWG mm
Wire Type	Solid
Remote Wiring Configuration Allowed	Yes
Tandem Wiring Configuration Allowed	Yes
Through Wiring Configuration Allowed	Yes
Max Ballast-Lamp Distance Remote Wiring	20'
Max Ballast-Lamp Distance Tandem Wiring	Blue = 20'
Max Ballast-Lamp Distance Through Wiring	Blue = 20'
Connector Type	No connector
Temperature	
T-Case Maximum (Nom)	70 °C
Mechanical and Housing	
Housing Material	Metal
Housing	N

Centium T5HO

Housing Dimensions	9.5" x 1.3" x 1.0"
Approval and Application	
EMC Immunity Standard	FCC Non-Consumer
Approval Marks	CSA certificate UL certificate CEC Listing NOM certificate RoHS Compliant
Hum And Noise Level	A
UL Recognized	No
Product Data	
Order product name	CENTIUM ELE BALLAST (2) F54T5/HO 120-277V

EAN/UPC - Product	781087110560
Order code	913701235101
Numerator - Quantity Per Pack	1
Numerator - Packs per outer box	10
Material Nr. (12NC)	913701235101
Net Weight (Piece)	0.350 kg

Dimensional drawing

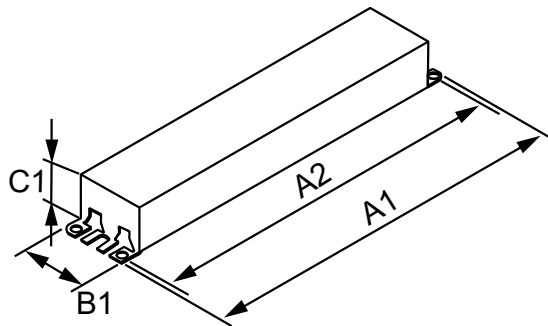

ELE BALLAST (2) F54T5/HO 120-277V

Product	A1	A2	B1	C1
CENTIUM ELE BALLAST (2) F54T5/HO 120-277V	9.5 in	8.90 in	1.3 in	1.0 in

